

Tdeck+™

Stage Decks



Tdeck+™ (U.S. Patent 9,631,385 / Canadian Patent 2,933,878) is a modular and highly customizable decking solution to meet the needs of your unique application.

- Decks bolt together to provide a stable, level walking surface
- Modular design can be configured into boundless possibilities
- Decks available in one foot increments, from 1' x 2' up to 4' x 8'

- Available with standard 3/4" covers, or supply your own plywood
- 1.5" Sch. 40 pipe legs for sturdiness can be cut to any standard or custom length
 - Fixed height legs
 - Adjustable height legs
 - Telescopic legs
- Flat pack shipping saves on transportation costs
- Available for purchase or rental

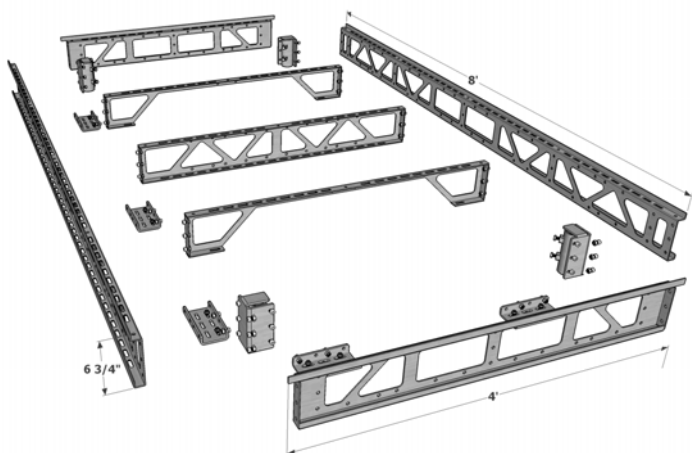



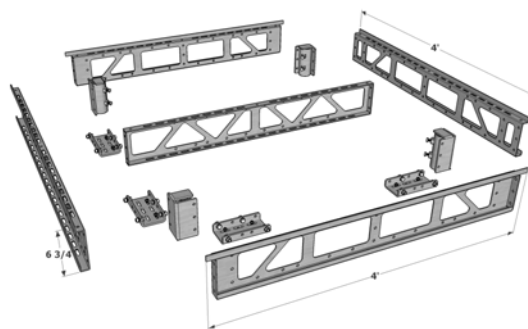







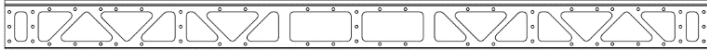
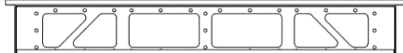
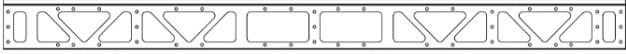

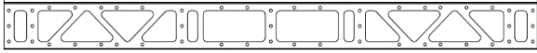
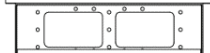
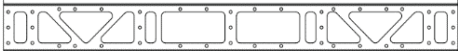
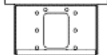
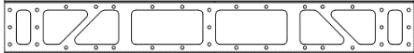

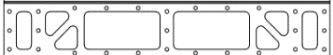
4' x 8' Tdeck+™ explosion
with Corner Bracket Pipe Sockets
and five Marriage Brackets

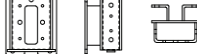

4' x 4' Tdeck+™ explosion
with Corner Bracket Pipe Sockets
and four Marriage Brackets

Live load rating: 150 psf (732 kg/m²)

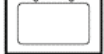
Total weight of 4' x 8' Tdeck with surface: 180 lbs (81.65 kg)

8' Side P/N# TD-PUI-RJ8 Weight: 16 lbs (7.3 kg) 	4' End P/N# TD-PUI-EFP4 Weight: 8 lbs (3.6 kg) 
7' Side P/N# TD-PUI-RJ7 Weight: 14 lbs (6.4 kg) 	3' End P/N# TD-PUI-EFP3 Weight: 7 lbs (3.2 kg) 
6' Side P/N# TD-PUI-RJ6 Weight: 12.5 lbs (5.7 kg) 	2' End P/N# TD-PUI-EFP2 Weight: 5 lbs (2.3 kg) 
5' Side P/N# TD-PUI-RJ5 Weight: 10 lbs (4.5 kg) 	1' End P/N# TD-PUI-E1 Weight: 3 lbs (1.4 kg) 
4' Side P/N# TD-PUI-RJ4 Weight: 8.5 lbs (3.9 kg) 	Corner Bracket Pipe Socket P/N# TD-PUI-CBP Weight: 2 lbs (0.9 kg) 
3' Side P/N# TD-PUI-RJ3 Weight: 6 lbs (2.7 kg) 	Corner Bracket 2x4 Socket P/N# TD-PUI-CB24 Weight: 3 lbs (1.4 kg) 
2' Side P/N# TD-PUI-RJ2 Weight: 4.5 lbs (2.0 kg) 	Corner Bracket 4x4 Socket P/N# TD-PUI-CB44 Weight: 4 lbs (1.8 kg) 
4' Middle Joist P/N# TD-PUI-MJ4 Weight: 6.5 lbs (2.9 kg) 	Corner Bracket for Caster P/N# TD-PUI-CBC Weight: 7.5 lbs (3.4 kg) 
3' Middle Joist P/N# TD-PUI-MJ3 Weight: 5 lbs (2.3 kg) 	2x4 Handrail Bracket P/N# TD-PUI-HB24 Weight: 3 lbs (1.4 kg) 
2' Middle Joist P/N# TD-PUI-MJ2 Weight: 3.5 lbs (1.6 kg) 	2" Pipe Bracket P/N# TD-PUI-HBP Weight: 3 lbs (1.4 kg) 
1' Middle Joist P/N# TD-PUI-MJ1 Weight: 1.5 lbs (0.7 kg) 	2" Pipe Passthrough Bracket P/N# TD-PUI-HBPP Weight: 2.5 lbs (1.3 kg) 
	Marriage Bracket P/N# TD-PUI-MB2 Weight: 2.5 lbs (1.3 kg) 

A product by:

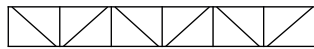

PRODUCTIONS UNLIMITED, INC.

www.productionsunlimitedinc.com

info@productionsunlimitedinc.com

Toll Free: 844.579.7455